

Disegno d'insieme generale

Montageanleitung / General assembly drawing / Fiche d'assemblage

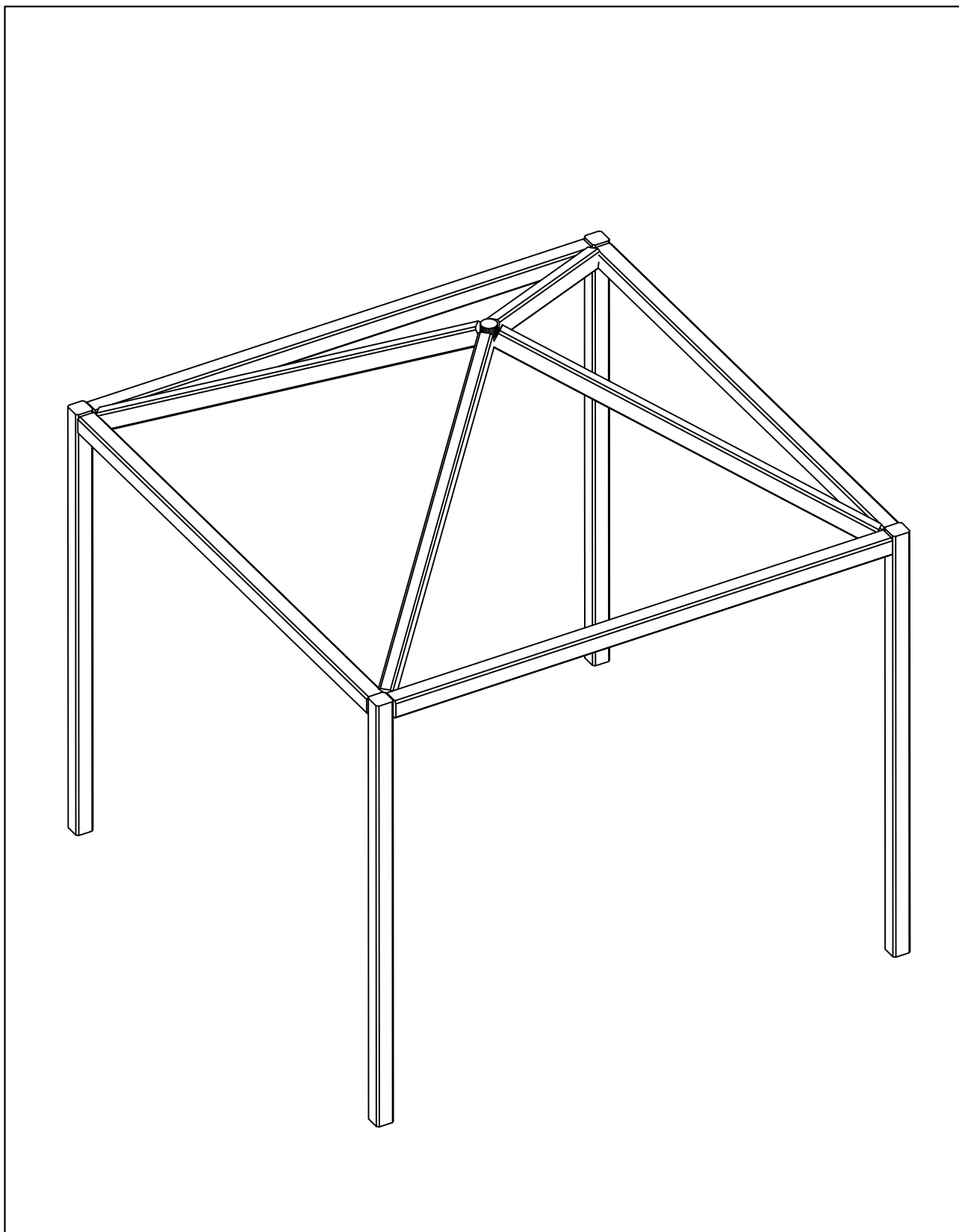

Art. **620005** Quadratischr Pavillon - 387x 387x 240/320h



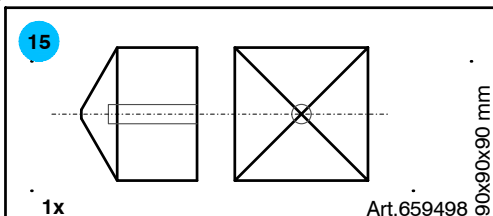
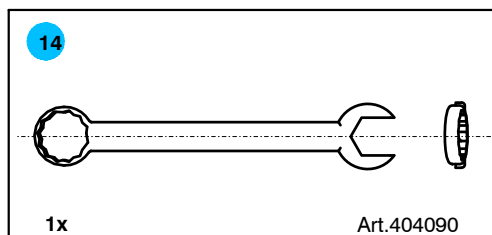
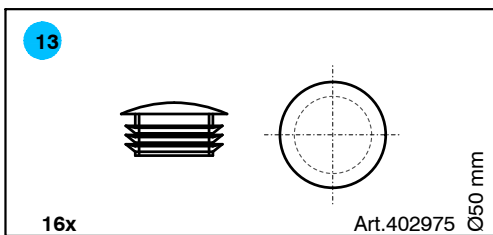
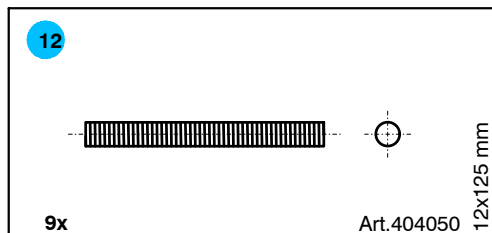
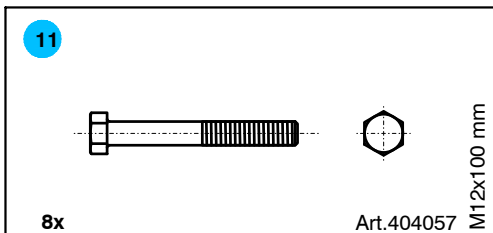
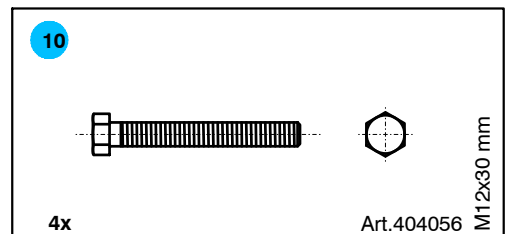
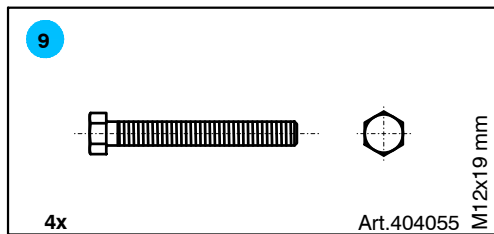
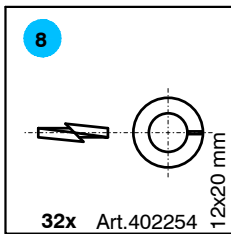
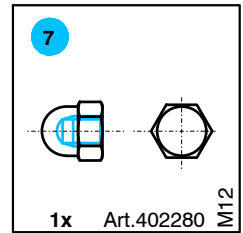
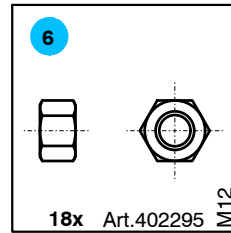
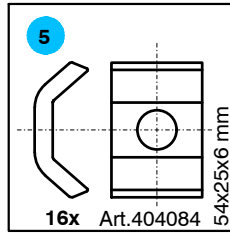
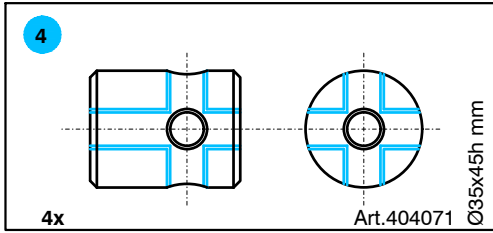
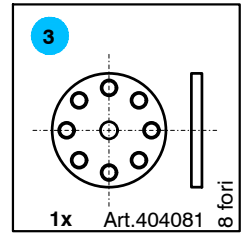
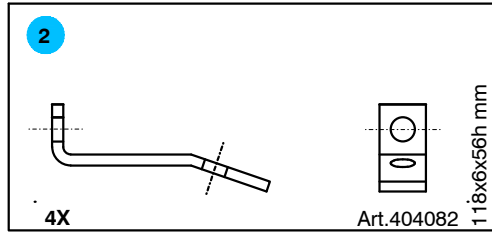
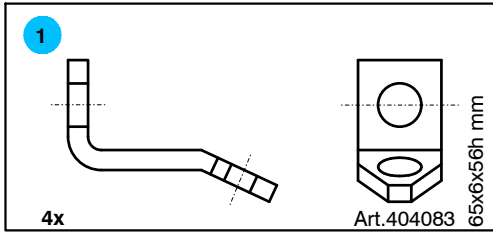

Ⓓ - La Pircher Oberland S.p.A. si riserva di apportare modifiche tecniche ed estetiche atte a migliorare i prodotti in qualsiasi momento e senza alcun preavviso. Attenzione: l'azienda non si assume alcuna responsabilità per montaggi eseguiti in maniera non conforme alle istruzioni allegate e per utilizzi non corretti dei prodotti. Per tutte le verifiche urbanistiche, statiche e di sicurezza è comunque richiesto l'intervento di un professionista di fiducia.

Ⓓ - Pircher Oberland S.p.A. reserves the right to make design and technical changes to improve the products in any moment without prior notice. Important: the company can in no way be responsible for damages or injuries resulting from assembly not in accordance with the enclosed instructions or for incorrect use of the products. All the town planning, stability and safety tests must be performed by a trusted professional.

Ⓓ - Pircher Oberland AG behält sich das Recht vor, jederzeit und ohne vorherige Benachrichtigung technische und ästhetische Produktverbesserungen vorzunehmen. Achtung: das Unternehmen haftet nicht für die unsachgemäße Montage oder nicht korrekte Verwendung der Produkte. Für alle urbanistischen, statischen, sowie die Sicherheit betreffenden Fragen ist eine qualifizierte Fachperson zu Rate zu ziehen.

Ⓓ - Pircher Oberland S.p.A. se réserve d'apporter toute modification technique et esthétique à même d'améliorer les produits à tout moment et sans aucun préavis. Attention: l'entreprise n'assume aucune responsabilité quant aux montages exécutés de manière non conforme aux instructions jointes et aux utilisations incorrectes des produits. Pour tous les contrôles urbanistiques, statiques et de sécurité, l'intervention d'une personne du métier est requise.

